

R MULTI-DRAWER CABINET

R MULTI-DRAWER CABINET

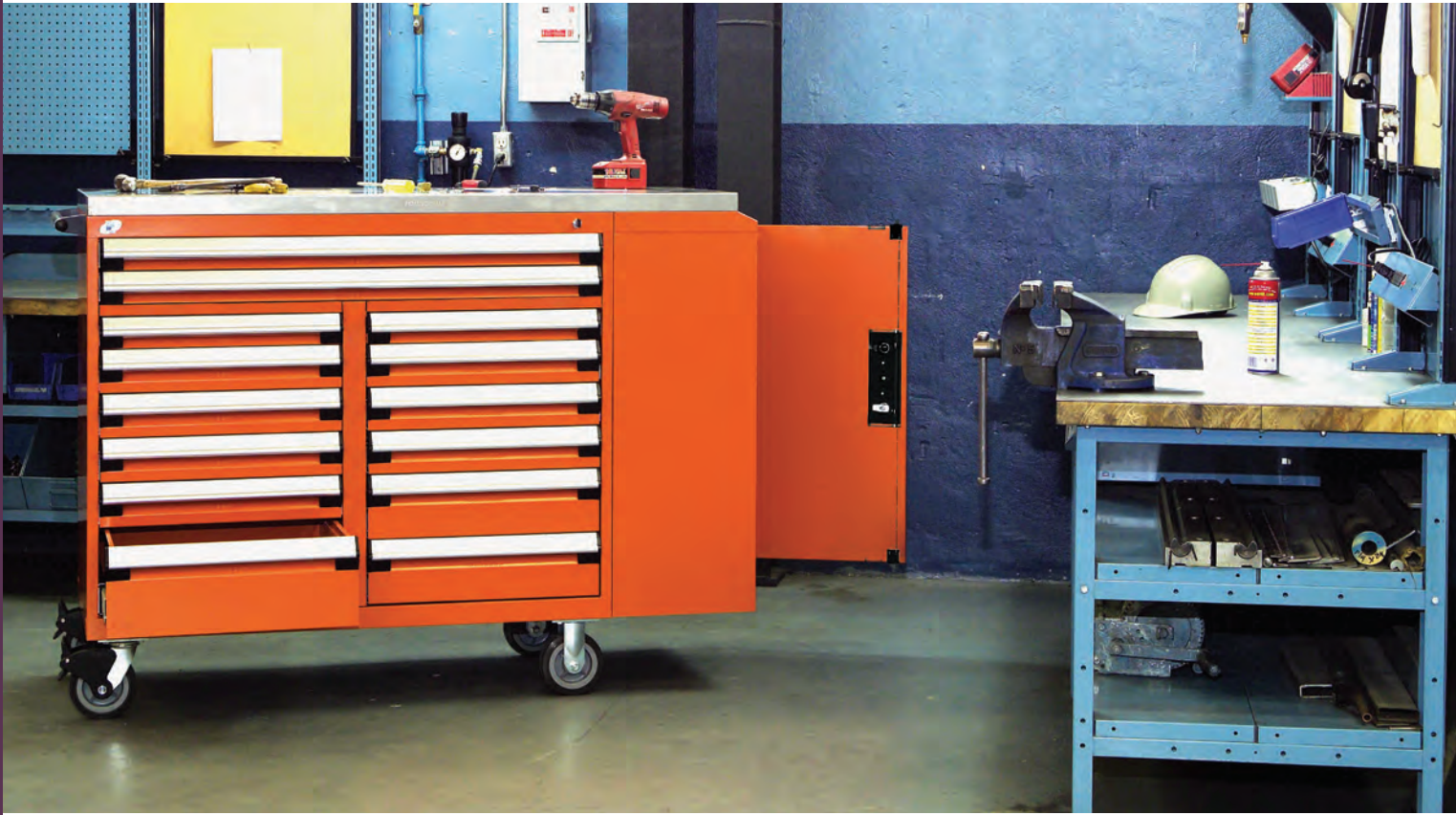

INDEX	PAGE(S)
R Multi-Drawer Cabinet	66-67
Preconfigured Models - R Mobile Cabinet	68 - 70
Preconfigured Models - R Stationary Cabinet	71 - 73
Accessories	74 - 75

R MULTI-DRAWER CABINET

For personalized management of your storage space, you will love the stylish design and impressive versatility of our R Multi-Drawer Cabinets. Whether you need just one unit or one hundred, our team will help you build your ideal configuration.

The cabinet is available in both stationary and mobile versions. The mobile version features superior-quality casters, a sturdy handle that provides a firm grip and an integrated lock-in mechanism for added safety when moving the cabinet around the workplace. All mobile and stationary models include a central locking system so all drawers can be locked at the same time, as well as stabilizing bars, which provided extra rigidity to the housing.

The multi-drawer cabinet is incredibly versatile, built to last and available in a wide variety of colors. And we are as proud of it as you will be!



R5XHE-1018

LIFETIME WARRANTY
The Rousseau drawer rolling mechanism is covered by a lifetime warranty.

THE ROUSSEAU ADVANTAGES



The integrated lock-in mechanism activates easily with just one hand (right or left).

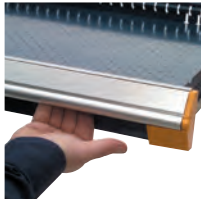

The full-width ergonomic handle provides a comfortable grip when opening the drawer.

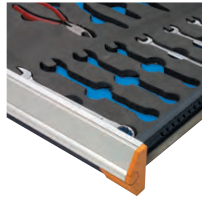

Variety of drawer accessories available: partitions, dividers, plastic bins, protective foam, etc.



Polyurethane casters for excellent maneuverability without marking floors. Total-lock brake system available.



Variety of cabinet accessories available: foldaway shelves, storage cabinets, wood tops, etc.

GENERAL DIMENSIONS

Multi-drawer cabinets are available in different sizes and with different partition options. Contact Customer Service to create your own custom configuration.

MOBILE

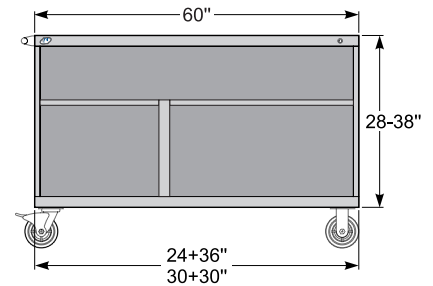
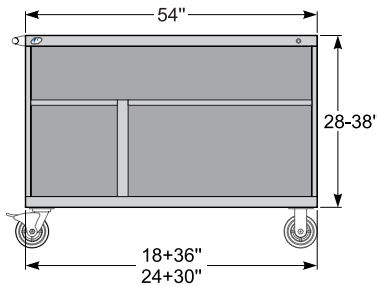
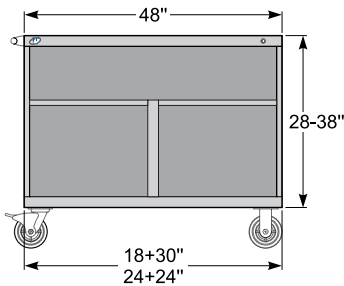

STATIONARY

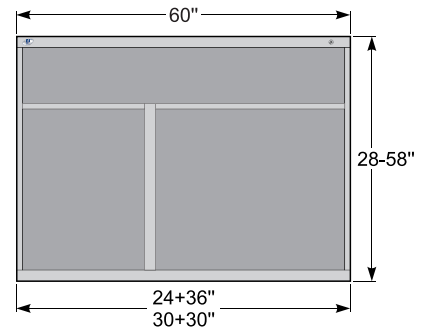
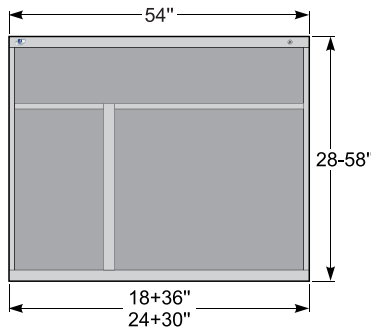
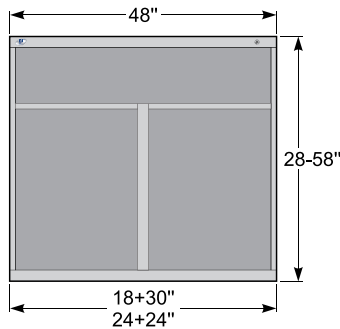

NOTE: The narrower bank of drawers is always installed on the left. e.g., 24"W to the left and 36"W to the right.

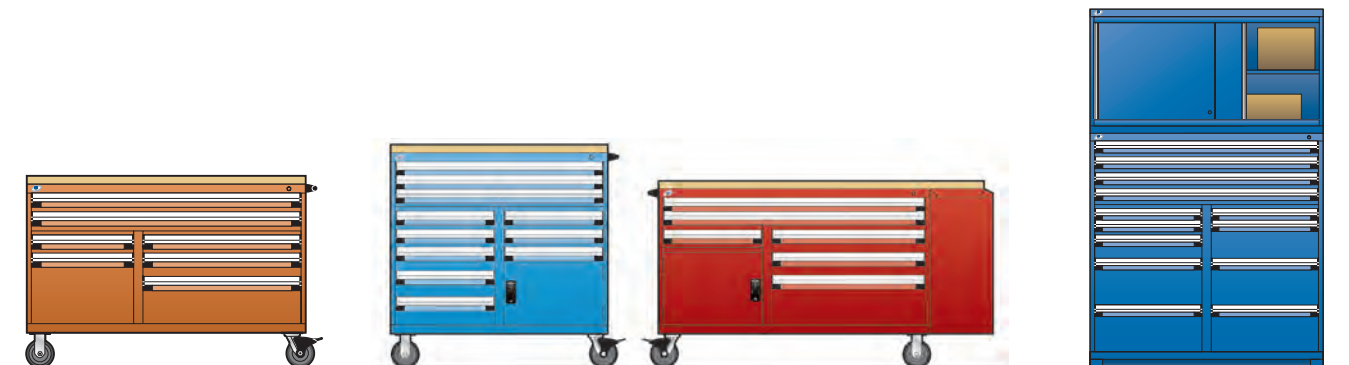

PRECONFIGURED MODELS - R MULTI-DRAWER MOBILE CABINETS

HERE ARE SOME OF OUR MOST POPULAR PRECONFIGURED MODELS OF R MULTI-DRAWER MOBILE CABINETS

- Preconfigured models for multi-drawer mobile cabinets have four 6" casters, including two rigid and two swivel casters with total-lock brakes (superior industrial quality, non-marking polyurethane wheels)
- R Multi-drawer Mobile Cabinets include stabilizing bars to provide extra rigidity to the housing
- All cabinets include a standard cabinet lock (L3) and an integrated lock-in mechanism A on each drawer
- To order a safety hasp LP, [see page 45](#), contact Customer Service
- To order an electronic lock L50, [see page 75](#), contact Customer Service
- To add a stainless steel, painted steel, steel with rubber mat, wood or marine edge stainless steel top, [see page 46](#)
- Each model includes a wide-grip side handle for easier cabinet handling
- Please contact your Customer Service representative for a more personalized configuration



NOTE: For interior drawer dimensions, [see pages 206-208](#).

IMPORTANT

Drawer compartments are included in all models. See the number of compartments and suggested layouts below.

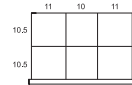

To order drawers without compartments, replace the last two digits of the model number with the next even number up.

Ex.: R5GHE-3003 with R5GHE-3004 without



DRAWER DIMENSIONS	NUMBER OF COMPARTMENTS (LAYOUT CODE)		
	3"H TO 5"H	6"H TO 8"H	9"H AND HIGHER
18"W x 24"D	6 (0104)	4 (0102)	2 (0100)
18"W x 27"D	6 (0104)	4 (0102)	2 (0100)
24"W x 24"D	12 (0308)	9 (0206)	6 (0104)
24"W x 27"D	20 (0316)	12 (0209)	6 (0104)
30"W x 24"D	30 (0524)	12 (0308)	9 (0206)
30"W x 27"D	25 (0420)	12 (0308)	9 (0206)
36"W x 24"D	30 (0524)	12 (0308)	9 (0206)
36"W x 27"D	30 (0425)	12 (0308)	6 (0203)
48"W x 24"D	40 (0732)	18 (0512)	8 (0304)
48"W x 27"D	32 (0724)	15 (0410)	8 (0304)
54"W x 24"D	40 (0930)	18 (0512)	10 (0405)
54"W x 27"D	40 (0930)	18 (0512)	10 (0405)
60"W x 24"D	70 (1356)	24 (0716)	12 (0308)
60"W x 27"D	84 (1370)	21 (0614)	12 (0308)

48" WIDE (W x D x H)



To prevent the mobile cabinet from tipping, distribute the load evenly.



12 DRAWERS	
R5GHE-3023	48" x 24" x 37 1/2"
R5GHG-3023	48" x 27" x 37 1/2"



10 DRAWERS	
R5GHE-3005	48" x 24" x 37 1/2"
R5GHG-3005	48" x 27" x 37 1/2"



6 DRAWERS	
R5GHE-3019	48" x 24" x 37 1/2"
R5GHG-3019	48" x 27" x 37 1/2"



9 DRAWERS	
R5GHE-3009	48" x 24" x 37 1/2"
R5GHG-3009	48" x 27" x 37 1/2"



9 DRAWERS	
R5GHE-3419	48" x 24" x 41 1/2"
R5GHG-3419	48" x 27" x 41 1/2"



9 DRAWERS	
R5GHE-3415	48" x 24" x 41 1/2"
R5GHG-3415	48" x 27" x 41 1/2"



11 DRAWERS	
R5GHE-3405	48" x 24" x 41 1/2"
R5GHG-3405	48" x 27" x 41 1/2"



12 DRAWERS	
R5GHE-3809	48" x 24" x 45 1/2"
R5GHG-3809	48" x 27" x 45 1/2"



9 DRAWERS	
R5GHE-3835	48" x 24" x 45 1/2"
R5GHG-3835	48" x 27" x 45 1/2"



10 DRAWERS	
R5GHE-3813	48" x 24" x 45 1/2"
R5GHG-3813	48" x 27" x 45 1/2"



11 DRAWERS	
R5GHE-3815	48" x 24" x 45 1/2"
R5GHG-3815	48" x 27" x 45 1/2"



12 DRAWERS	
R5GHE-3817	48" x 24" x 45 1/2"
R5GHG-3817	48" x 27" x 45 1/2"

PRECONFIGURED MODELS - R MULTI-DRAWER MOBILE CABINETS

54" WIDE (W x D x H)

R MULTI-DRAWER CABINET



8 DRAWERS	
R5GJE-3001	54" x 24" x 37 1/2"
R5GJG-3001	54" x 27" x 37 1/2"



7 DRAWERS	
R5GJE-3003	54" x 24" x 37 1/2"
R5GJG-3003	54" x 27" x 37 1/2"

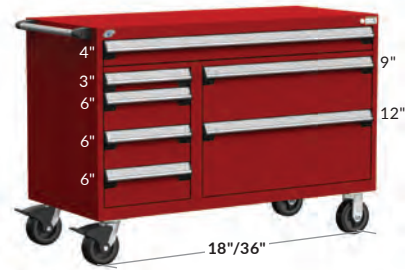

7 DRAWERS	
R5GJE-3005	54" x 24" x 37 1/2"
R5GJG-3005	54" x 27" x 37 1/2"



7 DRAWERS	
R5GJE-3007	54" x 24" x 37 1/2"
R5GJG-3007	54" x 27" x 37 1/2"



9 DRAWERS	
R5GJE-3401	54" x 24" x 41 1/2"
R5GJG-3401	54" x 27" x 41 1/2"



8 DRAWERS	
R5GJE-3403	54" x 24" x 41 1/2"
R5GJG-3403	54" x 27" x 41 1/2"



9 DRAWERS	
R5GJE-3405	54" x 24" x 41 1/2"
R5GJG-3405	54" x 27" x 41 1/2"



10 DRAWERS	
R5GJE-3407	54" x 24" x 41 1/2"
R5GJG-3407	54" x 27" x 41 1/2"



10 DRAWERS	
R5GJE-3801	54" x 24" x 45 1/2"
R5GJG-3801	54" x 27" x 45 1/2"



10 DRAWERS	
R5GJE-3803	54" x 24" x 45 1/2"
R5GJG-3803	54" x 27" x 45 1/2"



12 DRAWERS	
R5GJE-3805	54" x 24" x 45 1/2"
R5GJG-3805	54" x 27" x 45 1/2"



11 DRAWERS	
R5GJE-3807	54" x 24" x 45 1/2"
R5GJG-3807	54" x 27" x 45 1/2"

PRECONFIGURED MODELS - R MULTI-DRAWER MOBILE CABINETS

60" WIDE (W x D x H)



10 DRAWERS
 R5GKE-3005 60" x 24" x 37½"
 R5GKG-3005 60" x 27" x 37½"



7 DRAWERS
 R5GKE-3015 60" x 24" x 37½"
 R5GKG-3015 60" x 27" x 37½"



9 DRAWERS
 R5GKE-3009 60" x 24" x 37½"
 R5GKG-3009 60" x 27" x 37½"



10 DRAWERS
 R5GKE-3403 60" x 24" x 41½"
 R5GKG-3403 60" x 27" x 41½"



11 DRAWERS
 R5GKE-3405 60" x 24" x 41½"
 R5GKG-3405 60" x 27" x 41½"



9 DRAWERS
 R5GKE-3823 60" x 24" x 45½"
 R5GKG-3823 60" x 27" x 45½"



9 DRAWERS
 R5GKE-3825 60" x 24" x 45½"
 R5GKG-3825 60" x 27" x 45½"



10 DRAWERS
 R5GKE-3813 60" x 24" x 45½"
 R5GKG-3813 60" x 27" x 45½"



8 DRAWERS
 R5GKE-3827 60" x 24" x 45½"
 R5GKG-3827 60" x 27" x 45½"



PRECONFIGURED MODELS - R MULTI-DRAWER STATIONARY CABINETS

HERE ARE SOME OF OUR MOST POPULAR PRECONFIGURED MODELS OF STATIONARY MULTI-DRAWER CABINETS

- Preconfigured models for R Multi-Drawer Stationary Cabinets include a 2" front access forklift base (kick plate included)
- R Multi-Drawer Stationary Cabinets include stabilizing bars to provide extra rigidity to the housing
- To add a stainless steel, painted steel, steel with rubber mat, wood or marine edge stainless steel top, [see page 12](#)
- All cabinets include a standard cabinet lock (L3)
- For a safety hasp (LP), [see page 11](#), contact Customer Service
- For an electronic lock (L50), [see page 75](#), contact Customer Service
- Please contact your Customer Service representative for a more personalized configuration



NOTE: For interior drawer dimensions, [see pages 206-208](#).

IMPORTANT

Drawer compartments are included in all models. See the number of compartments and suggested layouts below.

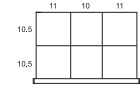

To order drawers without compartments, replace the last two digits of the model number with the next even number up.

Ex.: R5KHE-3005 with
R5KHE-3006 without



NUMBER OF COMPARTMENTS (LAYOUT CODE)

DRAWER DIMENSIONS	3"H TO 5"H	6"H TO 8"H	9"H AND HIGHER
18"W x 24"D	6 (0104)	4 (0102)	2 (0100)
18"W x 27"D	6 (0104)	4 (0102)	2 (0100)
24"W x 24"D	12 (0308)	9 (0206)	6 (0104)
24"W x 27"D	20 (0316)	12 (0209)	6 (0104)
30"W x 24"D	30 (0524)	12 (0308)	9 (0206)
30"W x 27"D	25 (0420)	12 (0308)	9 (0206)
36"W x 24"D	30 (0524)	12 (0308)	9 (0206)
36"W x 27"D	30 (0425)	12 (0308)	6 (0203)
48"W x 24"D	40 (0732)	18 (0512)	8 (0304)
48"W x 27"D	32 (0724)	15 (0410)	8 (0304)
54"W x 24"D	40 (0930)	18 (0512)	10 (0405)
54"W x 27"D	40 (0930)	18 (0512)	10 (0405)
60"W x 24"D	70 (1356)	24 (0716)	12 (0308)
60"W x 27"D	84 (1370)	21 (0614)	12 (0308)

48" WIDE (W x D x H)

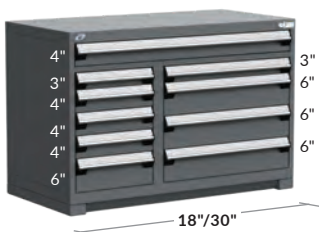

10 DRAWERS
R5KHE-3021 48" x 24" x 32"
R5KHG-3021 48" x 27" x 32"



7 DRAWERS
R5KHE-3015 48" x 24" x 32"
R5KHG-3015 48" x 27" x 32"



10 DRAWERS
R5KHE-3403 48" x 24" x 36"
R5KHG-3403 48" x 27" x 36"



11 DRAWERS
R5KHE-3405 48" x 24" x 36"
R5KHG-3405 48" x 27" x 36"

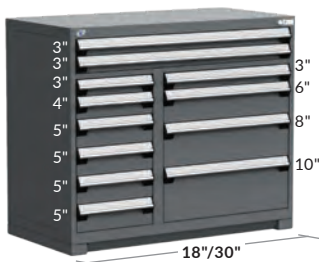

12 DRAWERS
R5KHE-3821 48" x 24" x 40"
R5KHG-3821 48" x 27" x 40"



13 DRAWERS
R5KHE-3811 48" x 24" x 40"
R5KHG-3811 48" x 27" x 40"



12 DRAWERS
R5KHE-3817 48" x 24" x 40"
R5KHG-3817 48" x 27" x 40"



11 DRAWERS
R5KHE-4409 48" x 24" x 46"
R5KHG-4409 48" x 27" x 46"

R MULTI-DRAWER CABINET

PRECONFIGURED MODELS - R MULTI-DRAWER STATIONARY CABINETS



54" WIDE (W x D x H)

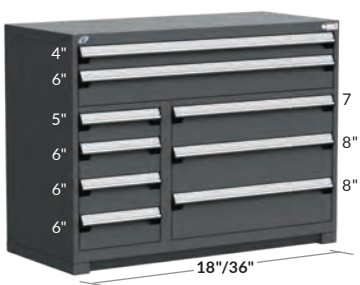

PRECONFIGURED MODELS - R MULTI-DRAWER STATIONARY CABINETS

60" WIDE (W x D x H)

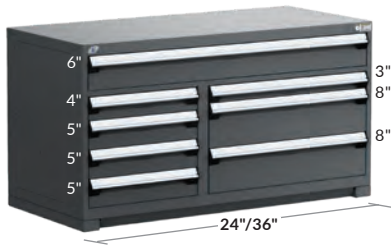

8 DRAWERS
 R5KKE-3007 60" x 24" x 32"
 R5KKG-3007 60" x 27" x 32"



10 DRAWERS
 R5KKE-3403 60" x 24" x 36"
 R5KKG-3403 60" x 27" x 36"



11 DRAWERS
 R5KKE-3405 60" x 24" x 36"
 R5KKG-3405 60" x 27" x 36"



12 DRAWERS
 R5KKE-3809 60" x 24" x 40"
 R5KKG-3809 60" x 27" x 40"



10 DRAWERS
 R5KKE-3813 60" x 24" x 40"
 R5KKG-3813 60" x 27" x 40"



11 DRAWERS
 R5KKE-4405 60" x 24" x 46"
 R5KKG-4405 60" x 27" x 46"



10 DRAWERS
 R5KKE-4407 60" x 24" x 46"
 R5KKG-4407 60" x 27" x 46"



18 DRAWERS
 R5KKE-5813 60" x 24" x 60"
 R5KKG-5813 60" x 27" x 60"



12 DRAWERS
 R5KKE-5819 60" x 24" x 60"
 R5KKG-5819 60" x 27" x 60"

ACCESSORIES

SIDE PANELS



SIDE UTILITY PANEL

RC02



- 5S storage accessory
- Maximizes the cabinet's storage space
- Installs on the sides of R cabinets
- Quick and easy installation
- Includes perforations spaced 1" apart c/c for hanging a range of hooks
- Load capacity: 50lb./sq. ft., 500lb. max. per panel
- Compatible with WM9F, WM9G, WM9H, WM9J and WM9L light-duty hooks, and WM9A and WM9B heavy-duty hooks
- Compatible with WMQ9 tool holders, WM9C bin rails, WM9D can holders, WM9M and WM9N hooks, WM9P spool and roll holders, and WM21 shelves
- Available in all standard R cabinet dimensions (depth, height)
- To order: Specify the housing height required, e.g., RC02-2434 for a 24"D x 34"H housing

PRODUCT NO.	CABINET DEPTH
RC02-18 __	18"
RC02-21 __	21"
RC02-24 __	24"
RC02-27 __	27"

NOTE: Full height installation only.

SIDE PANEL FOR PLASTIC BINS

RC04



- 5S storage accessory
- Maximizes the cabinet's storage space
- Installs on the sides of R cabinets
- Quick and easy installation
- Holds RG20 plastic bins
- Compatible with all commercially available brands of plastic bins with a hanging lip
- Available in all standard R cabinet dimensions (depth, height)
- To order: Specify the housing height required: RC04-2434 for a 24"D x 34"H housing

PRODUCT NO.	CABINET DEPTH
RC04-18 __	18"
RC04-21 __	21"
RC04-24 __	24"
RC04-27 __	27"

NOTE: Full height installation only.



SECURITY MECHANISMS

ELECTRONIC LOCK FOR CABINET WITH DRAWERS L50



- Electronically locks all drawers in the cabinet at the same time
- No key required
- Up to 20 different users can be programmed
- 4 to 8 digit access codes
- Simplifies access management to drawers
- To order the complete mechanism with a cabinet with drawers, order an RB01-WWDDHHL50
- To order as a replacement lock, order an HA62-L50
- One electronic lock system per cabinet. Electronically locks all drawers in the cabinet at the same time

PRODUCT NO.
L50

ELECTRONIC LOCK FOR DOORS L50



- Electronically locks a cabinet door
- No key required
- Up to 20 different users can be programmed
- 4-8 digit access codes
- Compatible with single, double and polycarbonate swing doors, with or without frame (RB61, RB62, RB66, RB67, RB75 and RB76)
- To order: Add L50 to the door product code, e.g. RB61-3620L50

PRODUCT NO.
L50

R CABINET BUMPERS



- Protects R cabinets from bumps and damage
- Protection kit for all four corners of cabinets
- Vertical bumpers and endcaps made from resistant soft PVC
- Quick and easy installation with double-sided adhesive tape
- Tool-free installation
- To order: Specify the housing height required, e.g., RB9J-30 02 for installation on a 30"H R cabinet and an RD01 side housing

PRODUCT NO.	COMPATIBLE WITH
RB9J- _ 01	RA35 cabinet
RB9J- _ 02	RA35 cabinet and RD01 side housing
RB9J- _ 03	RA35 cabinet and 1 RC02 / RC04 utility panel
RB9J- _ 04	RA35 cabinet and 2 RC02 / RC04 utility panels

NOTES: Not compatible with RB10 vertical security bars.
Not compatible with RC00 foldaway shelves.
Not compatible with RB75 and RB76 doors with frame.

VERTICAL SECURITY BAR RB10

RB10

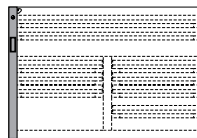

- Two vertical bars are required on a multi-drawer cabinet, one on the right-hand side of the cabinet and one on the left
- Covers a bank of drawers from 18" to 54" high
- Allows full access to drawers even when installed against a wall
- Order two vertical security bars corresponding to the internal height of the cabinet, e.g., 54" bars for a 58"H cabinet
- To order, add A to the product number for the right bar and B for the left bar

PRODUCT NO.	HEIGHT
RB10-18LP_	18"
RB10-20LP_	20"
RB10-24LP_	24"
RB10-26LP_	26"
RB10-30LP_	30"
RB10-34LP_	34"
RB10-36LP_	36"
RB10-40LP_	40"
RB10-54LP_	54"

NOTE: The vertical security bar cannot be installed on the central partition.